

EXPERIMENTAL INVESTIGATION OF A SMALL-SCALE TWO STAGE ORGANIC RANKINE CYCLE ENGINE OPERATING AT LOW TEMPERATURE

Erika Ntavou^{1,*}, George Kosmadakis², Dimitris Manolakos³, George Papadakis⁴ and Dimitris Papantonis⁵

^{1,*} Agricultural University of Athens, Department of Natural Resources and Agricultural Engineering, Athens, Attica, Greece
edavou@aua.gr

² Agricultural University of Athens, Department of Natural Resources and Agricultural Engineering, Athens, Attica, Greece
gkosmad@aua.gr

³ Agricultural University of Athens, Department of Natural Resources and Agricultural Engineering, Athens, Attica, Greece
dman@aua.gr

⁴ Agricultural University of Athens, Department of Natural Resources and Agricultural Engineering, Athens, Attica, Greece
gpap@aua.gr

⁵ National Technical University of Athens, Department of Mechanical Engineering Fluid Section, Athens, Attica, Greece
papan@fluid.mech.ntua.gr

* Corresponding Author

ABSTRACT

A prototype two-stage heat-to-power engine based on the Organic Rankine Cycle (ORC) has been developed for operation at a wide thermal load input range, coming from variable thermal sources, such as evacuated tube solar collectors. The system is used to produce electrical energy through the expansion of a refrigerant (R245fa) in two scroll expanders which are connected in series. The intense fluctuation of the temperature and heat input dictates the use of a two-stage engine, for flexible and efficient operation even at low thermal load, thus these expansion machines can operate within a narrow pressure ratio range, showing high expansion efficiency up to 70%. When operating at high heat input both expanders operate, while for low heat input, the first expander is completely bypassed. The net capacity of the ORC engine is 10 kWe, when supplied with 100 kW of heat at a temperature of 130 °C.

This engine has been tested in an appropriate test-rig at the laboratory, using a controllable electrical heater as the heat source. The power produced by the two hermetic scroll expanders is driven to an electric panel through frequency inverters. This study presents the ORC engine testing results, when the heat transfer fluid is water with temperature of 95 °C (part-load operation). The engine is tested under both single and two-stage configuration and the heat input is varied with the regulation of the ORC feed pump speed. The measurements have shown that even at such low-temperature the thermal efficiency is adequate (up to 7% for single- and two- stage operation), and that the second expander can operate with increased isentropic efficiency up to 66%, while for the first one this value is much lower, due to its under-expansion (pressure ratio 1.7-2.7 for the first and 3-7 for the second expander).

The maximum thermal efficiency is observed for low pump speed, while the highest power production of 3.5 kW was noticed at single-stage operation, slightly higher than the 3.3 kW produced at the two-stage operation.

1. INTRODUCTION

In recent years, organic Rankine cycle (ORC) technology has become a field of intense research and it appears as a promising technology for conversion of low grade heat into useful work or electricity (Desai and Bandyopadhyay, 2009, Mago *et al.*, 2008). The research so far has been focused on both single and two-stage systems. The single-stage Organic Rankine Cycle using solar collectors as a heat source has been experimentally evaluated (Manolakos *et al.* 2005, 2007, 2009a, 2009b, Manolakos, 2006), along with the detailed simulation of its performance (Manolakos 2006, Manolakos *et al.* 2005, 2009a, 2009b). Concerning the two-stage ORC systems, the research is increasing in the aspect of design and simulation, in order to identify the improvement in efficiency in comparison to the single stage system (Kosmadakis *et al.*, 2010). In the present work a prototype two-stage engine, which has been constructed as a result of intense research, design and simulation work, is being experimentally evaluated for operation at 95°C for variable heat input. The engine is being tested for both single and two-stage operation and the heat in the laboratory is provided by an electrical heater of a capacity of 100 kW_{th}. A two-stage system is being selected for the current experiment in order to evaluate the expected offered flexibility to the system, since this design promises an efficient operation in a wide range of thermal power input. Even at partial or low thermal load, the first expander can be completely by passed if needed, and a *sufficient* operation is realized with only the second expander. The expander is a key element of the ORC. The choice of the expander strongly depends on the operating conditions and on the size of the facility and two main types of machines can be distinguished: the dynamic (turbo) and displacement (volumetric) type (Lemort *et al.*, 2009). Displacement type machines are more appropriate to the small-scale ORC unit because they are characterized by lower flow rates, higher pressure ratios and much lower rotational speeds than turbo-machines. Moreover, these machines can tolerate two-phase conditions, which may appear at the end of the expansion at some operating conditions. Among positive displacement machines, the scroll machine is a good candidate for the ORC application, because of its reduced number of moving parts, reliability, wide output power range, and broad availability. Moreover, it is a proven technology in compressor mode due to its extensive use in refrigeration and air-conditioning industry. However, up to now, the use of scroll machines in expander mode has mainly been limited to experimental work and so far numerous scroll expander prototypes have been tested for different fluids. In the current test, two hermetic sealed scroll compressors have been used as expanders (i.e. operated in reverse mode) after modification and their operation is carefully and separately tested. The hermetic expanders show the great advantage that they include in one compact unit all the necessary sub-systems (generator, lubrication system) that work efficiently and the chance of leakage is small while their cost is relatively low. The working fluid used is the refrigerant R-245fa.

2. DESCRIPTION OF THE SYSTEM

The two-stage ORC configuration that has been developed after intense research and which is being tested in the present work, is based on the use of an integrated system with the use of a single organic fluid and two scroll expanders (scroll compressors in reverse operation), connected in series. The organic fluid that has been selected according to previous analysis is R-245fa (Kosmadakis *et al.*, 2009). This configuration has been proven to be the best solution concerning the efficiency in a wide load range, as well as the cost and simplicity of the control system (Hung *et al.* 1997, Kosmadakis *et al.* 2010, Mago *et al.* 2008). In operation at a load lower than around 50-60% of the nominal, the first expander is being by-passed with the use of an electro valve, thus the evaporated organic fluid is being expanded only in the second expander. In this way, the pressure ratio fluctuation on which the expander efficiency is depended, is kept low in the whole load range (Manolakos *et al.* 2009a, 2009b). The main components of the developed engine are the heat transfer fluid pump, the organic fluid pump, the evaporator, the scroll expanders and the condenser. The organic fluid pump is a Wanner

axial- piston pump and it can operate at sufficiently high pressures with low mass flow, a combination needed in the present tested system. The maximum volume flow is 29 L/min and the maximum motor capacity is 2.2 kW at 960 rpm (50 Hz). The scroll expanders are Copeland scroll compressors that have been modified to operate reversely. The models that have been chosen are ZR125KCE-TFD for the first expander, with maximum inlet pressure 32 bar and power at the nominal pressure ratio 6.15 kW (isentropic efficiency 70.9% at compressor mode) and ZR190KCE-TFD for the second expander, with maximum pressure 32 bar and power at nominal pressure ratio 9.2 kW (isentropic efficiency 69.2% at compressor mode). Both expanders have an inner volume ratio around 3. The first expander is smaller than the second one in terms of swept volume (167.15 cm³/rev for the first and 249.16 cm³/rev for the second expander). The heat exchangers are of plate type that secure a good heat convection and negligible pressure drop from the inlet to the outlet. Their active surface is 9 m² and their capacity is 100 kW (both evaporators and the condenser). They are manufactured by Ciat and they are Ex1 14 70 type. Such a configuration is shown in Figure 1.

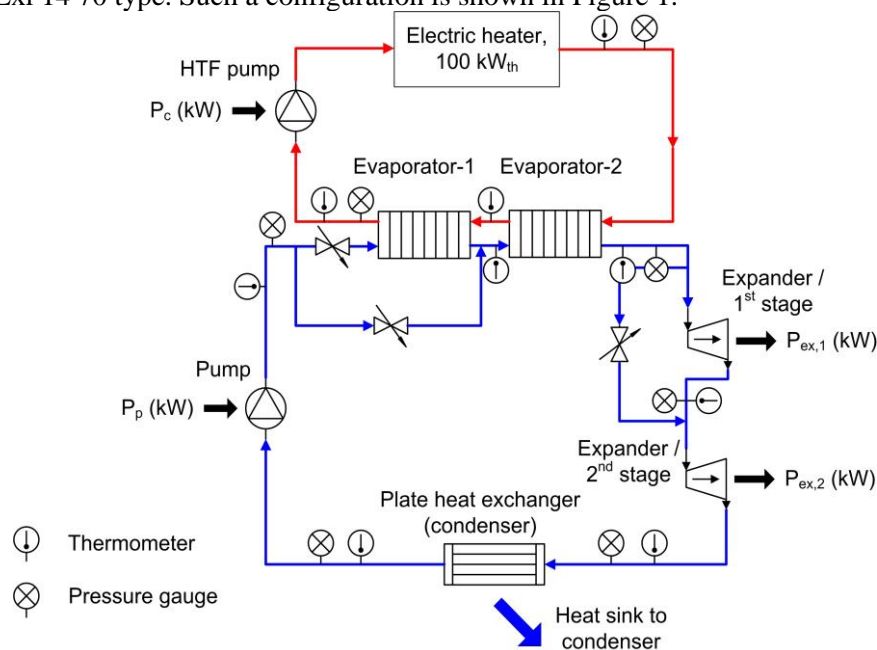

Figure 1: A two- stage ORC configuration with two expanders connected in series

For the heat source simulation, an electrical heater of a capacity of 100 kW_{th} is used and the heat transfer working fluid is water. At every inlet and outlet of each component, appropriate measurement instrumentation is used (thermocouples and pressure transducers). The digital output is shown on the electric panel of the engine. The fluid pump is driven by a frequency inverter, while the speed of the two expanders is regulated as well with the use of inverters connected with the dynamic electric brake. The single or two stage operation is set with the help of an electro valve, which allows a full by- pass of the first expander in medium/low load operation. Two ball-valves, which completely isolate the first branch of the first expander for maintenance service, are manually controlled for additional safety while changing the operation from one to two-stage.

The tests that were implemented at the laboratory aid in the evaluation of the engine's operation at several temperatures and conditions. The temperature and pressure of each location that are shown on the electrical panel are used to determine the organic fluid's condition. Consequently, the engine's efficiency can be calculated, as well as the characteristic properties for every operational point. In the present work the engine is being examined for the operation at 95°C and for variable heat input to the ORC evaporator (plate heat exchanger with capacity of 100 kW_{th}). In Figure 2, the integrated system that is installed in the laboratory as well as a close view of the scroll expanders are shown;



Figure 2: The integrated system installed in the laboratory and the scroll expanders

3. EXPERIMENTAL RESULTS AND EVALUATION

For water temperature of 95°C, the ORC engine has been tested for single and two-stage operation. In Figure 3 below, the optimum (i.e. highest efficiency value for each pump and expander(s) frequency combination) power production as a function of the heat input for each pump rotation speed is observed, in one and two-stage operation. The x- axis represents the total thermal input (in kW_{th}) which is given by Equation (1) below;

$$Q_{th} = (h_{orc\,ev\,out} - h_{orc\,ev\,in}) * m_{orc\,p} \quad (1)$$

where $h_{orc\,ev\,out}$ and $h_{orc\,ev\,in}$ are the enthalpy [kJ/kg] in the evaporator's output and input accordingly and $m_{orc\,p}$ is the organic fluid's mass flow rate [kg/s],
The y- axis represents the sum of the power production of each expander ($P_{orc\,ex}$) and is the sum of the measured produced power in [kW]

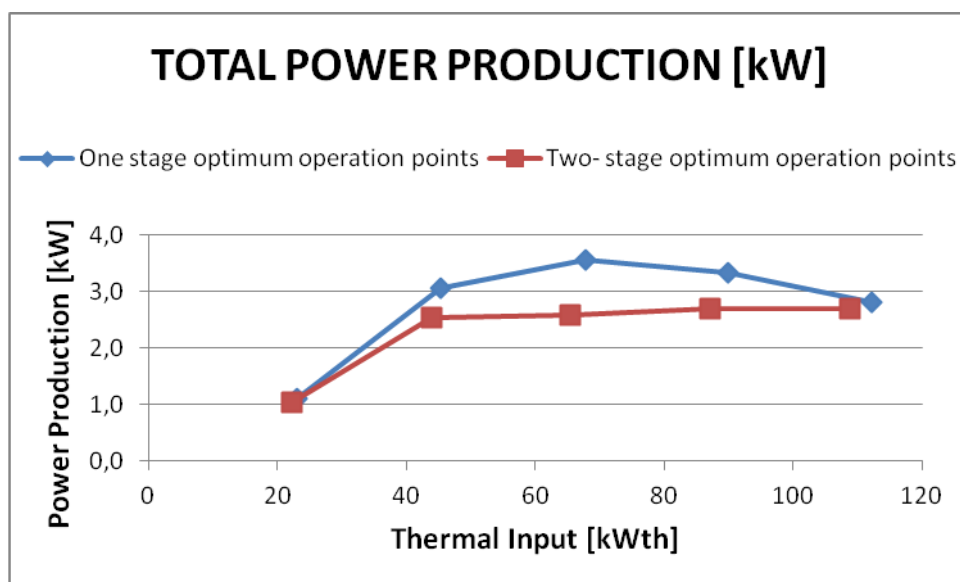

Figure 3: Power production as a function of the thermal input, one and two- stage operation

In Figure 3, it is observed that the maximum power production for one stage operation is noticed at around 3.5 kW for thermal input around 70 kW_{th} and pump rotation at 30 Hz frequency and expander

frequency at 40 Hz. As the pump rotation speed increases, the organic fluid mass that can absorb the transferred heat increases and as a result the power production increases accordingly up to the maximum value of 3.5 kW. However, from that point, in high pump rotation speed, the expander is not capable of expanding the fluid so efficiently, and the power production starts to decrease. In Figure 3, it is also observed that in two- stage operation, the maximum power production is around 2.7 kW for 40 and 50 Hz pump's frequency and 20 Hz at the first and 50 Hz at the second expander. The thermal load for these operating points is above 90 kW_{th}. Beyond that point, the curve tends to get a constant value, as noticed in Figure 3, and the system power production remains under 3 kW. It should be high lightened though, that the operation temperature (95 °C) is still moderate in comparison to the design temperature of the engine (120°~ 140°C), and this is one of the reasons that the produced power remains below the expected one (~10kW_e).

In Figure 4 the total thermal efficiency of the ORC engine is presented as a function of the thermal input, for the optimum operation points for several pump rotation speeds, in one and two stage operation. The x- axis represents once again the thermal input Q_{th} given from Equation (1), while the y- axis represents the thermal efficiency given by Equation (2);

$$\eta_{th} = \frac{[(P_{orc}]_{ex} - P_{orc p})}{Q_{th}} * 100 \quad (2)$$

where $P_{orc ex}$ is the sum of the measured expanders' power production (see above) and $P_{orc p}$ represents the pump's power consumption (in kW) and is equal to ;

$$P_{orc p} = [(h)_{orc p out} - h_{orc p in}] * m_{orc p} \quad (3)$$

where $h_{orc p out}$ and $h_{orc p in}$ are the enthalpy [kJ/kg] at the output and the input of the ORC pump accordingly.

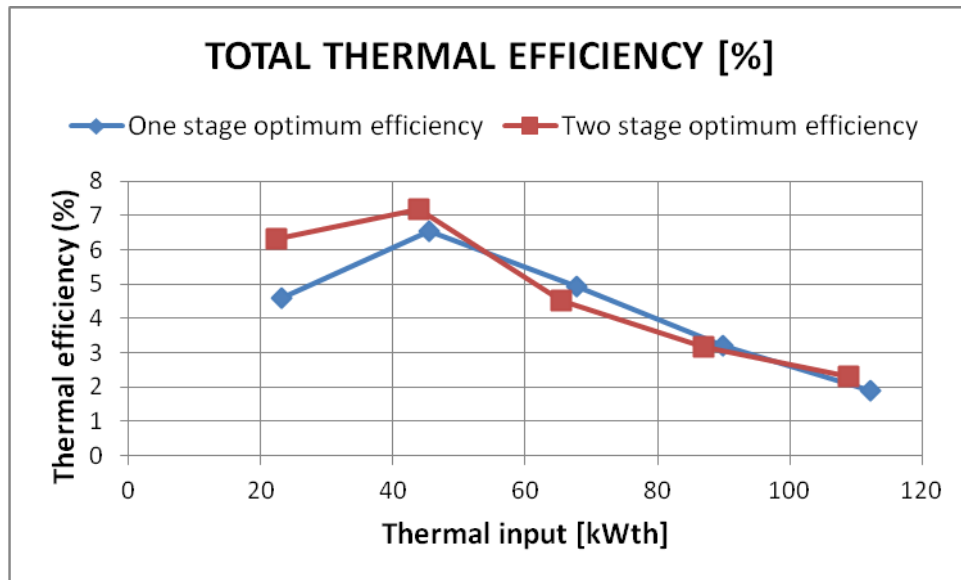

Figure 4: Thermal efficiency as a function of the thermal input, one and two- stage operation

In Figure 4 is observed that in one stage operation the thermal efficiency is noticed at around 6.8 % for thermal input at around 50 kW_{th} while in two- stage operation it is slightly increased reaching 7.2 % for thermal input at around 50 kW_{th}. In both cases, the thermal efficiency is decreased with the increase of pump's speed due to the increase of the own- consumption of the system (organic fluid pump consumption), since the efficiency is the ratio of the net power production to the thermal input.

In Figure 5, the relation between the heat input and the organic fluid pump’s rotational speed in one and two- stage operation is presented;

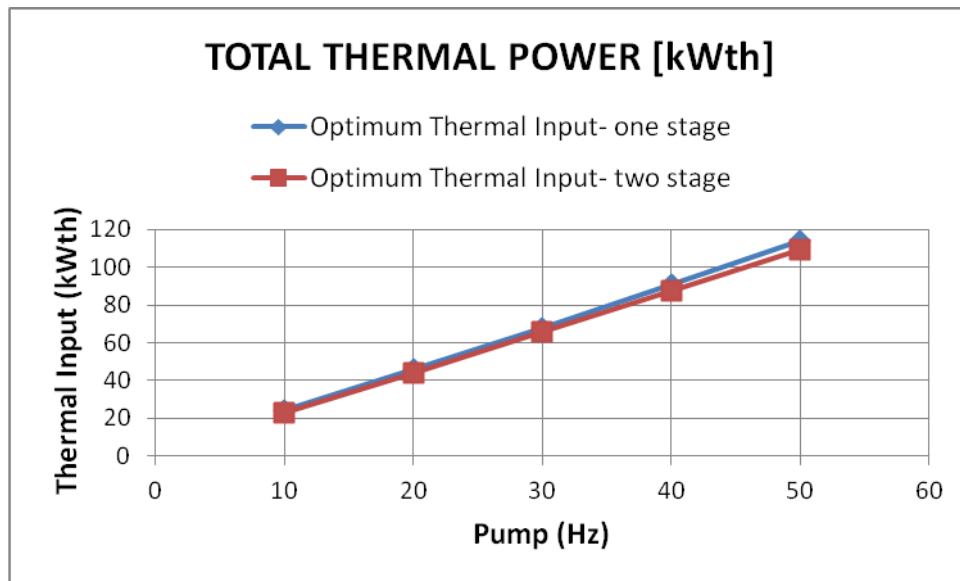

Figure 5: Thermal input as a function of the pump’s frequency, one and two- stage operation

As presented in Figure 5, the thermal input in one stage operation reaches slightly higher levels than in two- stage operation, since the maximum is noticed at around 119 kW_{th}. However, for the most of the organic fluid pump’s operation, the thermal input curves almost coincide for both operations. Finally, since the two scroll expanders have been modified from commercial scroll compressors and their operation is crucial for the evaluation of the whole system’s operation, it is important to examine their operation separately. In Figure 6, the relation between the pressure ratio and the expander’s frequency for several pump’s rotation speeds is presented, while in Figures 7 and 8 the same curves are being drawn for the two expanders in the two- stage operation. The x- axis represents the second expander’s set frequency at each operation point, while the pressure ratio is given by the ratio;

$$Pressure\ ratio = \frac{P_{orc\ ex\ in}}{P_{orc\ ex\ out}} \quad (4)$$

where $P_{orc\ ex\ in}$ and $P_{orc\ ex\ out}$ are the measured pressure [bar] at the inlet and outlet of the expander under investigation, accordingly.

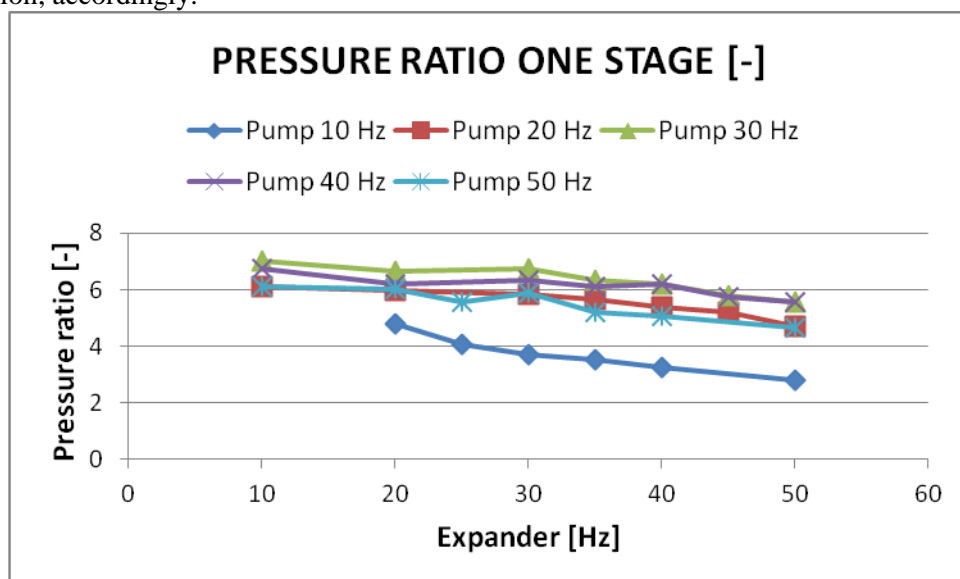

Figure 6: Pressure ratio as a function of the expander’s frequency, one stage operation

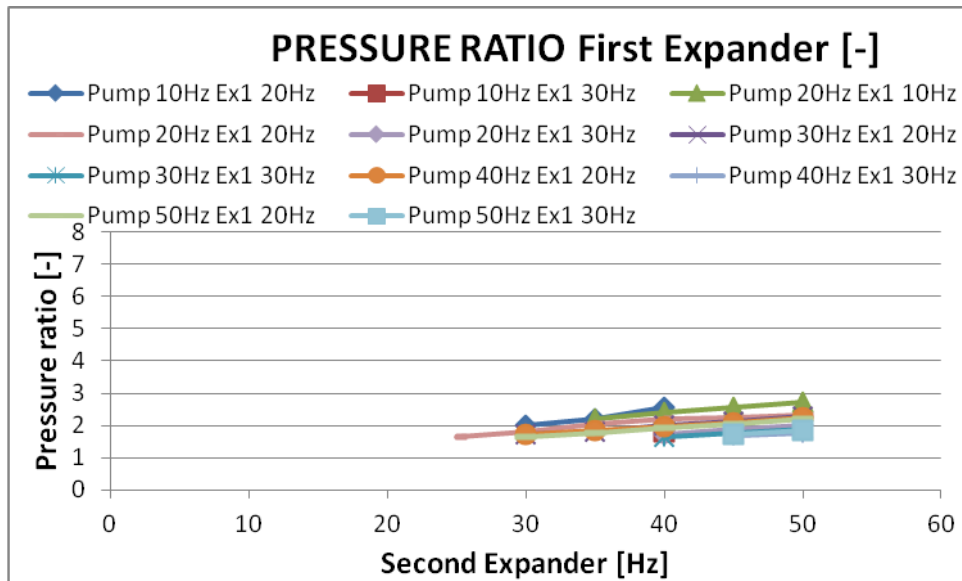

Figure 7: Pressure ratio as a function of the first expander's frequency, two- stage operation

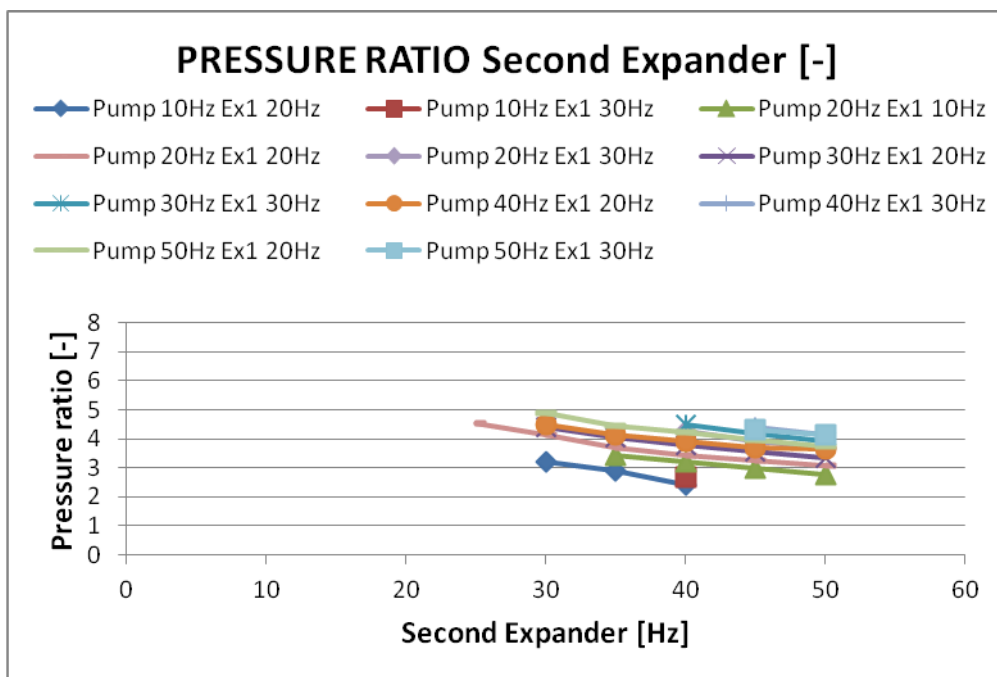

Figure 8: Pressure ratio as a function of the second expander's frequency, two- stage operation

In one stage operation the pressure ratio is around 6 and 7 for medium and high pump frequency, while for low pump frequency it is lower. As the expander's frequency increases for constant pump rotational speed, the organic fluid's inlet pressure decreases thus the pressure ratio decreases as well. The maximum pressure ratio which shows the most efficient operation point is noticed for pump frequency at 30 Hz and expander's frequency at 10 Hz.

In Figures 7 and 8, it is observed that the pressure ratio of the first expander is significantly lower, since for constant operation it gets values from 1 to 3 lower than the second one. With the increase of the pump's frequency the pressure ratio of the first expander decreases (inlet pressure lower than the pressure at the exit) while the ratio of the second increases. With the increase of the second

expander's frequency the first expander's pressure ratio increases while the second expander's decreases, due to a decrease of the inlet pressure. Consequently the pressure ratio decreases.

A good evaluation of the expanders' operation derives from their isentropic efficiency (the ratio of the actual work output of the expander to the work output of the expander if the expander undergoes an isentropic process between the same inlet and outlet pressure). In Figures 9 and 10 the isentropic efficiency of the second expander (with higher swept volume) is presented for single and two- stage operation. The x- axis represents the expander's frequency set for each operation point, while the y- axis represents the isentropic efficiency of each expander given by the Equation (5);

$$\eta_{orc\ is} = \frac{P_{orc\ ex}}{m_{orc\ p} * (h_{orc\ ex\ in} - h_{orc\ ex\ out\ is})} * 100 \tag{5}$$

where $h_{orc\ ex\ in}$ is the enthalpy at the expander's inlet and $h_{orc\ ex\ out\ is}$ is the isentropic enthalpy of the expander [kJ/kg].

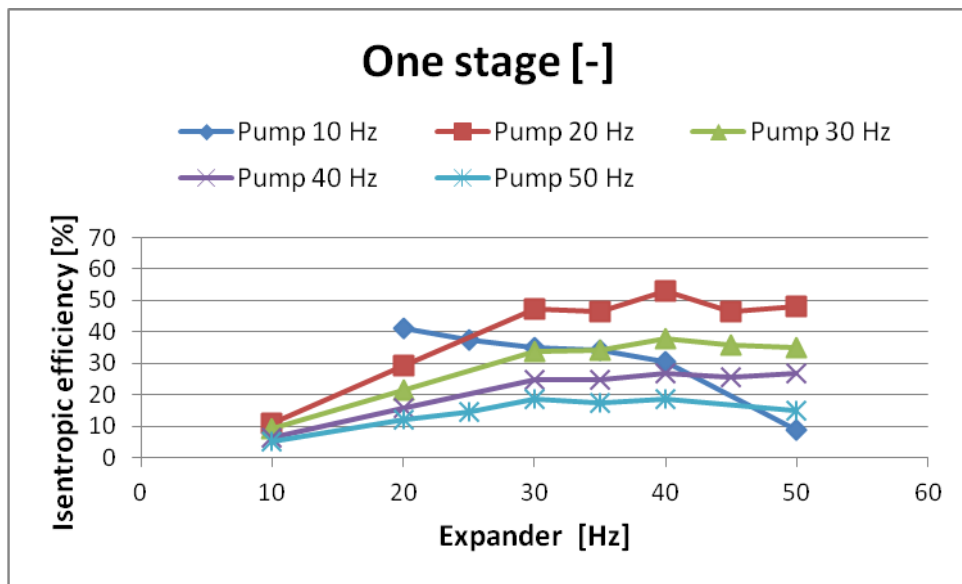

Figure 9: Isentropic efficiency of the second expander, one stage operation

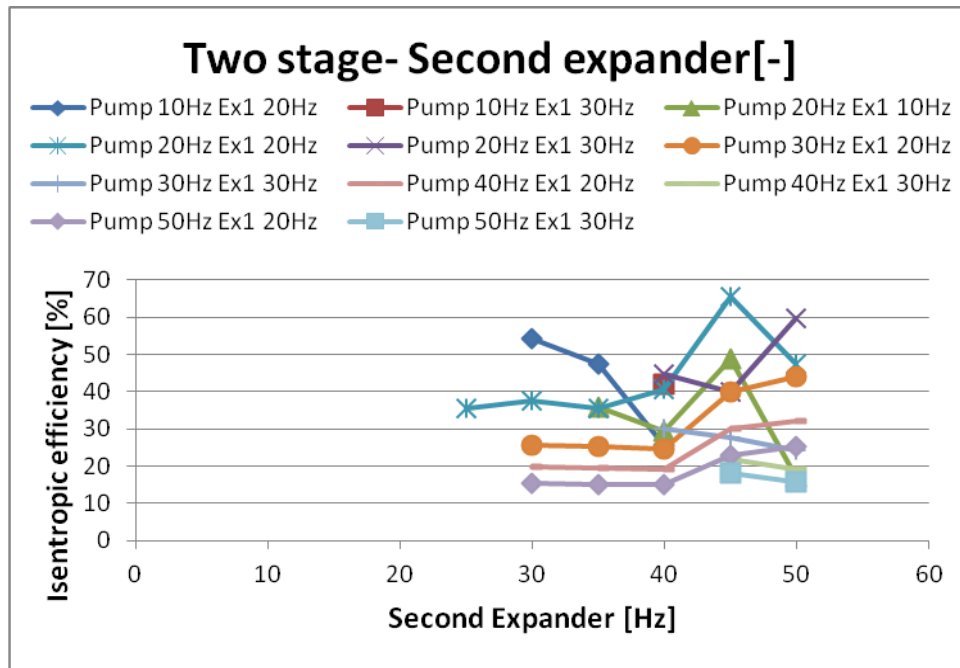

Figure 10: Isentropic efficiency of the second expander, two- stage operation

In both Figures 9 and 10, it is noticed that the second expander can operate with increased isentropic efficiency up to 66%, which implies a very good operation. According to Lemort *et al.* (2009), a tested open-driven scroll expander achieved a maximum isentropic efficiency of 68%, while Zanelli and Favrat (1994) carried out an experimental investigation on a hermetic scroll expander generator fed with refrigerant R134a and showed that the machine produced a power ranging from 1.0 to 3.5 kW with a maximal isentropic efficiency of 65%. The isentropic efficiency of the current expander is similar to those studies and signifies an effective operation. In Figure 10, it is also noticed that as the pump's frequency increases (thus the fluid mass flow increases) and the power production decreases, the expander's isentropic efficiency decreases as well, since the pressure ratio decreases, even if the electric efficiency of the asynchronous generator increases.

4. CONCLUSIONS

According to the tests in the laboratory the designed and manufactured engine worked efficiently even at a moderate temperature in comparison to the nominal design temperature. Even at one stage operation, a significant power production has been noticed for the whole heat load range, with a good efficiency throughout the whole operation. The selected and modified expanders have shown an efficient operation throughout the whole operation range of the pump and even if theoretically a pressure ratio of around 3 was expected for each expander in order to get the most of the two stage expansion, the first (and smaller) expander reached a pressure ratio of around 2 while the second one around 5 (total pressure ratio equals 10). In the current temperature (95°C), the single stage operation shows a slightly higher power output, since the power production is higher than the two- stage system, while the thermal efficiency is slightly lower. However, it should be stressed that the water temperature of the current test is still considerably lower than the design temperature of the modified two-stage ORC engine which is 130 °C and this is the main reason that the two- stage system has not proven any special improvement in comparison to the single stage system. What is of great importance is that the system tested shows that the two- stages expansion offers flexibility and these results deploy the potential of this technology, which appears to be promising possibly in combination with renewable energy heat sources.

REFERENCES

- Desai N.B., Bandyopadhyay S., 2009, Process integration of organic Rankine cycle, *Energy*, vol. 34, no.10: p.1674-1686
- Hung TC, Shai TY, Wang SK., 1997, A review of organic Rankine cycle (ORCs) for the recovery of low grade waste heat, *Energy*, vol. 22, no.7: p.661–67.
- Kosmadakis G., Manolakos D., Davou E. and Papadakis G., 2013, Implementation of a two-stage Organic Rankine Cycle using scroll expanders, operating under variable heat input, *2nd Int. Seminar on ORC Power Systems (ASME-ORC2013)*, Rotterdam, The Netherlands.
- Kosmadakis G., Manolakos D., Papadakis G., 2010, Parametric theoretical study of a two-stage solar organic Rankine cycle for RO desalination, *Renewable Energy*, vol. 35, no.5: p.989-996
- Kosmadakis G, Manolakos D, Kyritsis S, Papadakis G., 2009, Comparative thermodynamic study of refrigerants to select the best for use in the high-temperature stage of a two-stage organic Rankine cycle for RO desalination. *Desalination*, vol. 243, no. 1–3: p.74–94.
- Lemort V., Quoilin S., Cuevas C. and Lebrun J., 2009, Testing and modeling a scroll expander integrated into an Organic Rankine Cycle, *Applied Thermal Engineering*, vol. 29, no.14-15: p.3094-3102.
- Manolakos D, Papadakis G, Kyritsis S, Bouzianas K., 2007, Experimental evaluation of an autonomous low-temperature solar Rankine cycle system for reverse osmosis desalination. *Desalination*, vol.203, no.1-3: p.203-366.
- Manolakos D., 2006, Development of an Autonomous Low Temperature Solar Rankine Cycle System for Reverse Osmosis Desalination. *Ph.D thesis*, Agricultural University of Athens (in Greek, http://www.aua.gr/~kyritsis/abstract_workshop_Manolakos.pdf).
- Manolakos D, Kosmadakis G, Kyritsis S, Papadakis G., 2009, On site experimental evaluation of a low-temperature solar organic Rankine cycle system for RO desalination. *Solar Energy*, vol.83, no.5: p.646-656.
- Manolakos D, Kosmadakis G, Kyritsis S, Papadakis G., 2009, Identification of behavior and evaluation of performance of small scale, low temperature organic Rankine cycle system coupled with an RO desalination unit. *Energy*, vol.34, no.6: p.767-774.
- Manolakos D, Papadakis G, Mohamed Essam Sh, Kyritsis S, Bouzianas K., 2005, Design of an autonomous low-temperature solar Rankine cycle system for reverse osmosis desalination. *Desalination*, vol.183, no.1-3: p.73-80.
- Mago P.J., Chamra L.M., Srinivasan K., Somayaji C., 2008, An examination of regenerative organic Rankine cycles using dry fluids, *Appl Therm Eng*, vol. 28, no.8-9: p. 998–1007.
- Nguyen V.M., Doherty P.S. and Riffat S.B., 2001, Development of a prototype low-temperature Rankine cycle electricity generation system, *Appl. Therm. Eng.*, Vol. 21, no. 2, p.169–181.
- Quoilin S, Orosz M, Hemond H, Lemort V., 2011, Performance and design optimization of a low-cost solar organic Rankine cycle for remote power generation. *Solar Energy*, vol.85, no.5: p.955–966.
- Zanelli R., Favrat D., 1994, Experimental investigation of a hermetic scroll expander- generator, *Proceedings of the International Compressor Engineering Conference at Purdue*, paper 1021.

ACKNOWLEDGEMENT

The present work is conducted within the framework of the project with contract No. 09SYN-32-982, partly funded by the Greek General Secretary of Research and Technology (GSRT).